

micro  
v

me®

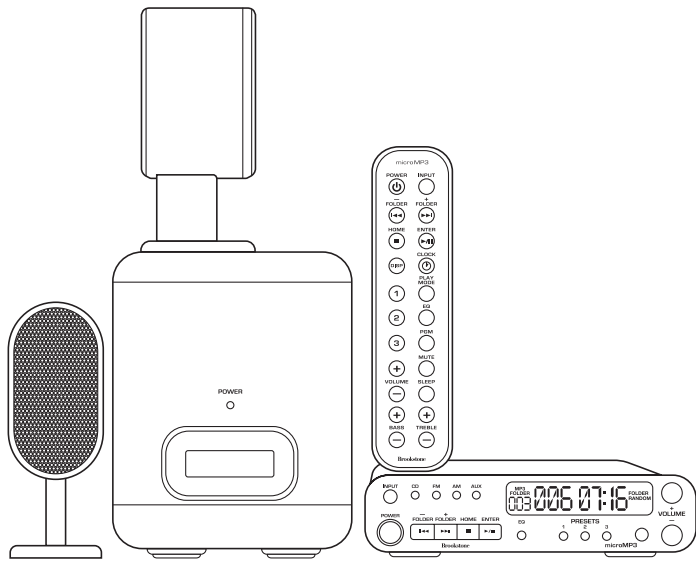

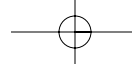

## MICRO CD SYSTEM WITH MP3

### **Brookstone makes life better.**

Our **Micro CD System with MP3** delivers amazing acoustical range—and fits just about anywhere. Twin, full-range speakers and a powerful, 33-watt subwoofer produce rich, clear, room-filling sound, taking your music into another dimension.

The Micro CD System with MP3 has been thoroughly tested to be certain it meets our own **exacting quality control standards**. Please take a few moments to review the following **important information** before using it.

**The mini system with full-size sound!**

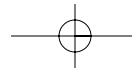

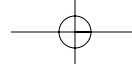

## CAUTION

- TO REDUCE THE RISK OF ELECTRIC SHOCK, DO NOT REMOVE COVER OR BACK. THERE ARE NO USER-SERVICEABLE PARTS INSIDE. REFER SERVICING TO QUALIFIED SERVICE PERSONNEL.
- TO REDUCE THE RISK OF FIRE OR ELECTRIC SHOCK, DO NOT EXPOSE THIS UNIT TO RAIN OR MOISTURE.



The lightning flash with arrow-head symbol within an equilateral triangle is intended to alert the user to the presence of uninsulated "dangerous voltage" within the unit's enclosure that may be of sufficient magnitude to constitute a risk of electric shock.



The exclamation point within an equilateral triangle is intended to alert the user to the presence of important operating and maintenance (servicing) instructions in the literature accompanying the unit.

## SPECIFICATIONS

Remote control uses one CR2025 button cell battery (included).

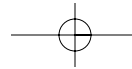

## CARE AND MAINTENANCE

### System

Wipe the housing gently with a soft, dry cloth. If the unit is heavily stained or soiled, wipe with a moistened cloth. To avoid damage, do not use any cleaning agents or abrasive cleaners.

### Speakers

Wipe the speakers gently with a clean, damp cloth. To avoid damage, do not use any cleaning agents or abrasive cleaners.

### CD Lens

When the lens gets dirty, malfunctions may occur. The lens should be cleaned using a commercially available camera lens cleaner.

### CD Compartment

- Do not put anything except a compact disc into compartment. Other objects can damage the mechanism.
- Do not force the compartment open.
- Keep the compartment closed when not in use to prevent dirt and dust from settling inside.
- Never place multiple discs into the compartment at the same time.

## IMPORTANT SAFETY INSTRUCTIONS

1. READ INSTRUCTIONS  
All the safety and operating instructions should be read before the unit is operated.
2. RETAIN INSTRUCTIONS  
The safety and operating instructions should be retained for future reference.
3. HEED WARNINGS  
All warnings on the unit and in the operating instructions should be adhered to.
4. FOLLOW INSTRUCTIONS  
All operating and use instructions should be followed.
5. WATER AND MOISTURE  
The unit should not be used near water—for example, near a bathtub, washbowl, kitchen sink, laundry tub, in a wet basement, or near a swimming pool.
6. CARTS AND STANDS  
The unit should be used only with a cart or stand that is recommended by the manufacturer.
7. A UNIT AND CART COMBINATION SHOULD BE MOVED WITH CARE  
Quick stops, excessive force, and uneven surface may cause the unit and cart combination to overturn.

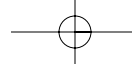

#### 8. WALL OR CEILING MOUNTING

The unit should be mounted to a wall or ceiling only as recommended by the manufacturer.

#### 9. VENTILATION

The unit should be situated so that its location or position does not interfere with its proper ventilation. For example, the unit should not be situated on a bed, sofa, rug or similar surface that may block the ventilation openings or placed in a built-in installation, such as a bookcase or cabinet that may impede the flow of air through the ventilation openings.

#### 10. HEAT

The unit should be situated away from heat sources such as radiators, heat registers, stoves, or other units (including amplifiers) that produce heat.

#### 11. POWER SOURCE

The unit should be connected to a power supply only of the type described in the operating instructions or as marked on the unit.

#### 12. GROUNDING OR POLARIZATION

Precautions should be taken so that the grounding or polarization means of a unit is not defeated.

#### 13. POWER CORD PROTECTION

Power-supply cord should be routed so that it is not likely to be walked on or pinched by items placed upon or against it, paying particular attention to cord at outlets, convenience receptacles, and the point where it exits the unit.

#### Improving FM Reception

Fully unwind the FM WIRE ANTENNA located on the back of the system and position it for best sound.

#### Replacing the Remote Control Battery

1. Slide the BATTERY COMPARTMENT open.
2. Remove the old battery and insert a new CR2025 battery into the battery compartment, ensuring the positive (+) side faces up.
3. Close the BATTERY COMPARTMENT.

**Note:** When the remote control is not going to be used for more than 30 days, remove the battery to prevent it from leaking. If it leaks, wipe away the liquid inside the BATTERY COMPARTMENT and replace with a new battery.

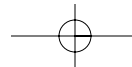

### Setting Radio Stations into Memory

You may store up to three FM stations and three AM stations in channel memory.

1. Press INPUT on the unit or remote to select FM or AM mode. The AM INDICATOR or FM INDICATOR illuminates on the unit.
2. Press - FOLDER/ **◀◀** or + FOLDER/ **▶▶** to select the desired station.
3. Press and hold PRESET 1, PRESET 2 or PRESET 3 on the unit or 1, 2, or 3 on the remote for three seconds. The unit beeps and the desired preset number appears on the unit's display. The station is now saved.  
**Note:** If it has been previously set, the former station is replaced.
4. Repeat Steps 2 and 3 to store additional stations.

### Playing Preset Stations

1. Press INPUT on the unit or remote to select FM or AM mode.
2. Press PRESET 1, PRESET 2 or PRESET 3 on the unit or 1, 2, or 3 on the remote to hear your desired station.

### Improving AM Reception

Reposition the unit to get better AM reception.

### 14. PROTECTIVE ATTACHMENT PLUG

The unit is equipped with an attachment plug having overload protection. This is a safety feature. See Instruction Manual for replacement or resetting of protective device. If replacement of the plug is required, be sure the service technician has used a replacement plug specified by the manufacturer that has the same overload protection as the original plug.

### 15. CLEANING

The unit should be cleaned only as recommended by the manufacturer.

### 16. POWER LINES

An outdoor antenna should be located away from power lines.

### 17. OUTDOOR ANTENNA GROUNDING

If an outside antenna is connected to the receiver, be sure the antenna system is grounded so as to provide some protection against voltage surges and built-up static charges. Article 810 of the National Electrical Code, ANSI/NFPA 70, provides information with regard to proper grounding of the mast and supporting structure, grounding of the lead-in wire to an antenna-discharge unit, size of grounding conductors, location of antenna discharge unit, connection to grounding electrodes, and requirements for the grounding electrode. See Figure 1.

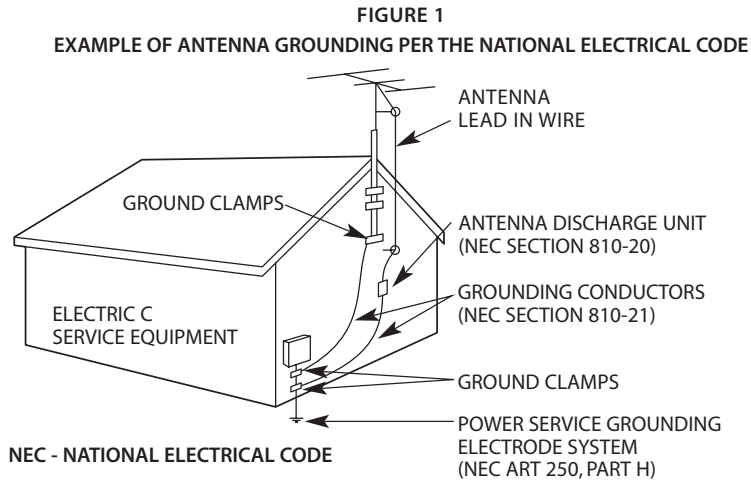

**18. NON-USE PERIODS**

The power cord of the unit should be unplugged from the outlet when left unused for a long period of time.

**19. OBJECT AND LIQUID ENTRY**

Care should be taken so that objects do not fall and liquids are not spilled into the unit through openings.

**Playing the Radio**

1. Press INPUT on the unit or remote to select FM or AM mode. The AM INDICATOR or FM INDICATOR illuminates on the unit.
2. Press - FOLDER/ ◀◀◀ or + FOLDER/ ▶▶▶ to select a radio station.
  - If you press - FOLDER/ ◀◀◀ or + FOLDER/ ▶▶▶ for less than three seconds each time, the receiving frequency moves up or down incrementally.
  - If you press and hold - FOLDER/ ◀◀◀ or + FOLDER/ ▶▶▶ for more than three seconds, the frequency continues to increase automatically until a radio station is received.

**Note:** The last tuned station is retained and recalled when you turn the system on. The tuned station is stored into memory, even if power is disconnected or cut due to temporary power failure.



### Muting Sound

1. Press MUTE on the remote control to silence audio output. MUTE appears on the display.
2. Press MUTE again to cancel this function and regain sound.

### Using Sleep Feature

This feature shuts off the system and goes into Standby mode when the selected sleep time has passed.

Sleep time can be set from 10-90 minutes.

Press SLEEP on the remote control to select the desired sleeping time. Your selection will appear on the display.

To cancel the sleep feature, press SLEEP until there is no sleep time on the display.

### 20. DAMAGE REQUIRING SERVICE

The unit should be serviced by qualified service personnel when:

- a) The power-supply cord or the plug has been damaged; or
- b) Objects have fallen, or liquid has been spilled into the unit; or
- c) The unit has been exposed to rain; or
- d) The unit does not appear to operate normally or exhibits a marked change in performance; or
- e) The unit has been dropped, or the enclosure damaged.

### 21. SERVICING

The user should not attempt to service the unit beyond that described in the operating instructions. All other servicing should be referred to qualified service personnel.

## LASER SAFETY

Laser CD players use invisible laser light and are equipped with safety switches to avoid exposure when the door is open and safety interlocks are defeated. It is dangerous to defeat or bypass safety switches. Avoid direct exposure to laser beam.

**Note:** Do not look directly into the laser. It may cause damage to eyes.

## WARNING

Hazardous laser radiation is present when the unit is open and interlocks are defeated.

## IMPORTANT

This unit may be sensitive to high levels of static electricity. If the unit powers off or the display becomes irregular, reset by unplugging the power cord for a minimum of 15 seconds.

## BATTERY PRECAUTIONS

- Dispose of the old battery properly. Do not dispose of the old battery in a fire.
- Do not leave the battery where a child or pet could play with or swallow it. If the battery is swallowed, contact a physician immediately.
- The battery may explode if mistreated. Do not attempt to recharge or disassemble the battery.

## FCC COMPLIANCE INFORMATION

This equipment has been tested and found to comply with the limits for a Class B digital device, pursuant to Part 15 of the FCC Rules. These limits are designed to provide reasonable protections against harmful interference in a residential installation. This equipment generates, uses and can radiate radio frequency energy and, if not installed and used in accordance with these instructions, may cause harmful interference to radio communications. However, there is no guarantee that interference will not occur in a particular installation.

### Adjusting Volume

Press VOLUME +/- on the remote control or main unit until the desired volume is reached.

### Adjusting Bass

Press BASS +/- on the remote control until the desired bass sound is reached.

### Adjusting Treble







Press TREBLE +/- on the remote control until the desired bass sound is reached.

### Changing Sound Quality with EQ

During play, press EQ repeatedly to select the preferred equalizer mode.



### Editing Programmed Memory

1. With the CD or MP3 in Stop mode, press PGM on the remote control repeatedly until you reach the track or folder you want to replace.
2. For CDs, press - FOLDER/  or + FOLDER/  to select the track you want to replace.  
For MP3s, press - FOLDER/  or + FOLDER/  to select the folder you want to replace. Press PGM to confirm your selection. Press - FOLDER/  or + FOLDER/  again to select the track you want to replace.
3. Press PGM again to confirm your selection.
4. Repeat Steps 2 and 3 to edit other programmed memory.

If harmful interference to radio or television reception should occur, determined by turning the equipment off and on, the user is encouraged to correct interference by trying one or more of the following measures:











- Relocate the receiving antenna.
- Increase the separation between equipment and receiver.
- Connect equipment to an outlet on a circuit different from receiver.
- Consult an experienced radio/TV technician for help.

## SAVE THESE INSTRUCTIONS



## LOCAT

### Programming CD and MP3 Play

This feature programs the order in which tracks are played. You may program up to 64 CD tracks and 64 MP3 tracks.

1. With the CD or MP3 in Stop mode, press PGM on the remote control. For CDs, 00 P--01 PRGM appears on the display.  
For MP3s, 000 flashes on the display, and P--01 PRGM appears.
2. Press - FOLDER/   or + FOLDER/   to locate the desired CD track or MP3 folder.
3. Press PGM to confirm your selection. For CDs, 00 P--002 PRGM appears on the display.  
For MP3s, 000 flashes on the display and P--01 PRGM appears.
4. For MP3s, press - FOLDER/   or + FOLDER/   again to locate the desired MP3 track. Press PGM to confirm your selection.
5. Repeat Steps 2-4 to program other tracks or folders for your desired sequence.
6. Press ENTER   to play your programmed sequence.

#### Note:

- After the last programmed track or folder is played, the CD or MP3 stops playing automatically. To replay the programmed sequence, press PGM, then ENTER  .
- To cancel programmed play, you can open the CD COMPARTMENT DOOR or press HOME  two times when you are in CD or MP3 mode.

### Repeating the Disc

Press PLAY MODE on the remote control until RPT ALL appears on the display.

**Note:** To exit this function, press PLAY MODE until RPT ALL disappears from the display.

### Repeating the MP3 Folder

Press PLAY MODE on the remote control until RPT FOLDER appears on the display.

**Note:** To exit this function, press PLAY MODE until RPT FOLDER disappears from the display.

### Displaying MP3 ID3 Information

During MP3 playback, press DISP on the remote control. The information about the current track displays as follows:

File (file name) > Title (track title) > Artist (artist name) > Album (album name).

**Note:**

- To exit this function, press DISP.
- The ID3 information enters the display from right to left.

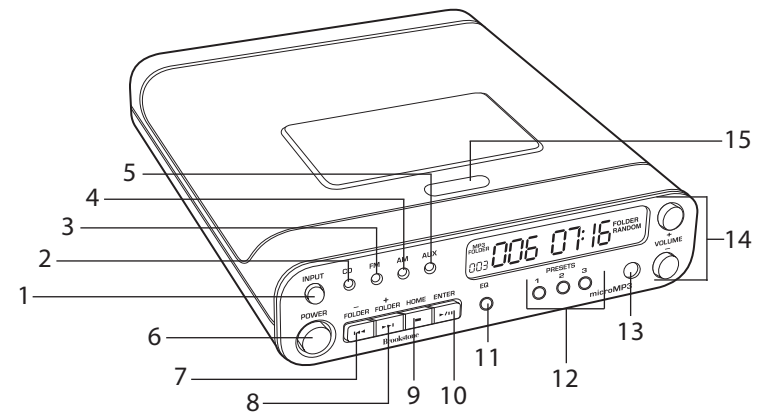

- 14. VOLUME +/- - Adjusts the sound level.
- 15. CD COMPARTMENT DOOR
- 16. DIMMER LOW/HIGH - Adjusts brightness of the display.
- 17. AUX IN - Jack that connect to an external auxiliary sound source (TV, VCR, DVD Player, cassette deck, mini disc player, etc.).

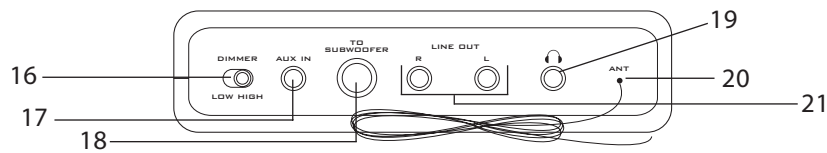

- 16. DIMMER - Knob that controls the volume.
- 17. AUX IN - Jack that connects to an auxiliary audio source.
- 18. TO SUBWOOFER - Jack that connects to the subwoofer.
- 19. (🎧) - Jack that connects to headphones.
- 20. FM ANTENNA - Jack that connects to the FM antenna.
- 21. LINE OUT (R, L) - Jacks that connect to external channel speakers.

- To temporarily stop CD or MP3 play, press ENTER ►|||. The playing time flashes on the display. Press ENTER ►||| again to resume play.
- Play stops automatically after all tracks have been played. The display shows the total number of tracks and folders and the total playing time.

#### Playing Tracks in Random Order



1. Repeatedly press PLAY MODE on the remote control until RANDOM appears on the display. The unit then plays all songs on the disc in random order.
2. To exit this function, press PLAY MODE until RANDOM disappears from the display. The disc continues playing to the end, but in the correct order.

#### Repeating One Track









1. With the CD or MP3 in Stop mode, press - FOLDER/ ◀◀◀ or + FOLDER/ ▶▶▶ to select a desired track.
2. Press PLAY MODE on the remote control until RPT 1 appears on the display. The selected track plays repeatedly.

**Note:** To cancel this function, press PLAY MODE until RPT 1 disappears from the display.

### Playing CDs and MP3s

1. With the unit on, press INPUT on the unit or remote control incrementally until the CD INDICATOR illuminates on the unit.
2. Press the CD COMPARTMENT DOOR and it lifts open.
3. Place your desired CD or MP3 into the tray with the label facing up.
4. Close the CD COMPARTMENT DOOR.
5. Press - FOLDER/  or + FOLDER/  on either the main unit or remote control to locate your desired CD or MP3 track.







**Note:**

- If your MP3s are in folders, press HOME  to enter the MP3 folder directory, then press - FOLDER/  or + FOLDER/  to locate your desired MP3 folder. After locating your desired MP3 folder, press HOME  to enter the folder, then press - FOLDER/  or + FOLDER/  to locate your desired track.
  - If you do not select a track or MP3 folder, the unit will play the disc from the beginning.
6. Press ENTER  on either the main unit or remote control to begin play. The display shows the track number and playing time. For MP3s, the display also shows the folder.
  7. To stop CD or MP3 play at any time, press HOME .

**Note:**

- Press and hold - FOLDER/  or + FOLDER/  to search any desired point within a track or MP3 folder.

### Remote Control

22. POWER  - Switches the power on and off.
23. - FOLDER/  - Skips backwards through a disc or track in CD mode; skips backwards through radio stations in Tuner mode; skips backwards through folders in MP3 mode; or skips backwards through time in Clock mode. Press and hold for faster reverse.
24. HOME  - Stops CD or programmed play or enters the MP3 folder directory.
25. DISP - Displays ID3 Information.
26. (1,2,3) - Three preset buttons for desired FM or AM stations.
27. VOLUME +/- - Adjusts the sound level.
28. BASS +/- - Adjusts bass sound.
29. INPUT - Toggles between CD, FM, AM and AUX modes.
30. + FOLDER/  - Skips forward through a disc or track in CD mode; skips forward through radio stations in Tuner mode; skips forward through folders in MP3 mode; or skips forwards through time in Clock mode. Press and hold for faster advance.
31. ENTER  - Plays and pauses CD play and MP3s.
32. CLOCK  - Sets the time.
33. PLAY MODE - Toggles between random CD play, repeating one track on a CD or repeating all tracks on a CD.
34. EQ - Selects equalizer mode (Flat, Rock, Pop and Jazz).

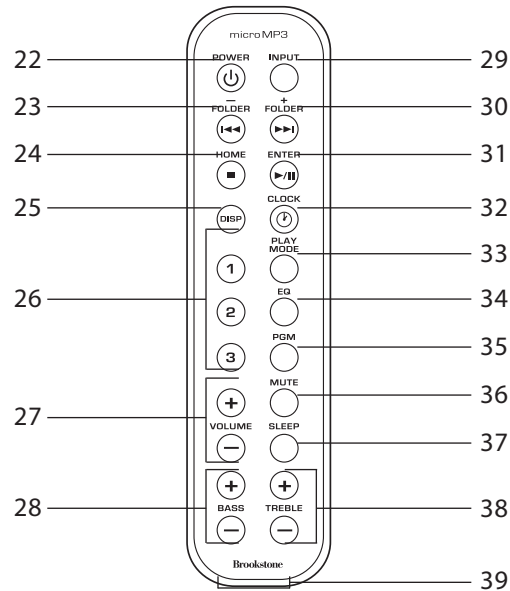

- 35. PGM - Programs CD or MP3 tracks into memory.
- 36. MUTE - Silences audio output.
- 37. SLEEP - Selects the sleeping time option in Sleep mode.
- 38. TREBLE +/- - Adjusts treble sound.
- 39. BATTERY COMPARTMENT

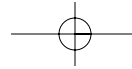

### Setting the Clock

1. Press and hold CLOCK (clock icon) on the remote control until the minutes begin flashing on the display.
2. Press - FOLDER/ ◀◀◀ or + FOLDER/ ▶▶▶ on the main unit or remote control until the correct time displays.
3. Press CLOCK (clock icon) to confirm your selection.

**Note:** The clock only displays in 12-hour mode. PM appears on the display for afternoon/evening hours. AM does not appear for morning hours.

### Turning the System On/Off

To turn the system on, press POWER (power icon) on the main unit or remote control. Press POWER (power icon) again to turn the unit off.

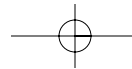



## SYSTEM OPERATION

### Using the Remote Control

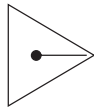

The remote control is required to set the clock and many other functions on the main unit.

To use the remote control, point it at the REMOTE SENSOR on the main unit for control from your listening position.

#### Note:

- Even if the remote control is within effective range, operation may be compromised by obstacles between the remote control and the main unit.
- If the remote control is operated near other units which generate infrared rays, or if other remote control devices using infrared rays are used near the unit, the remote control may operate incorrectly. Conversely, this remote control may make other units operate incorrectly.

### Subwoofer

40. POWER INDICATOR - Indicates power is on.

41. DC IN  - Jack that connects DC power cord to an electrical outlet.

42. TO CD DECK - Jack that connects the CD player to the subwoofer.

43. SPEAKER (4OHM) R L - Jacks that connect the right and left speakers to the subwoofer.

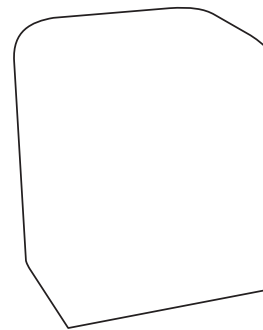

### Accessories

- 44. DC POWER CORD
- 45. MP3 CABLE
- 46. SUBWOOFER CABLE
- 47. LEFT SPEAKER CABLE
- 48. RIGHT SPEAKER CABLE

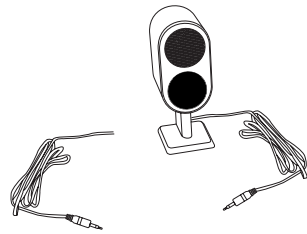

## SYSTEM SETUP

### Connecting the Unit

1. Connect one end of the SUBWOOFER CABLE into TO SUBWOOFER on the back of the unit, and the other end into TO CD DECK on the back of the subwoofer.
2. Insert the LEFT SPEAKER CABLE and RIGHT SPEAKER CABLE into L and R on the back of the subwoofer.
3. Insert one end of the DC POWER CORD into DC IN  on the back of the subwoofer, and the other end into an electrical outlet.

### Connecting the Unit to Another Audio Source

1. Insert one end of the MP3 CABLE into your audio source's headphone jack and the other end into AUX IN on the back of the unit.
2. With the unit On, press INPUT incrementally until the AUX INDICATOR illuminates on the unit.